

F1019

Name: Conic Side Table F1019
 Collection: Conic
 Application: Dining Table
 Construction: Natural Wood Veneer, MDF

Fixture Image



Specifications

Style: Modern Contemporary
 Design Year: 2023
 Maximum Supported Weight: Kg
 Table Weight: Kg

Technical Drawing

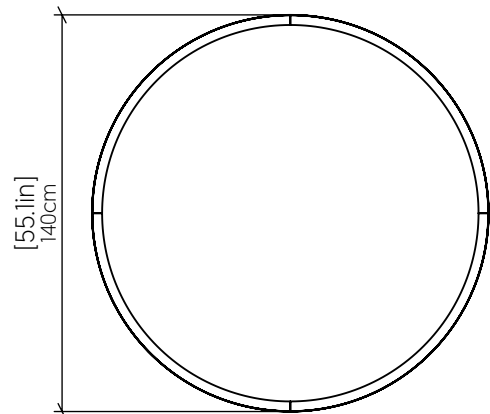
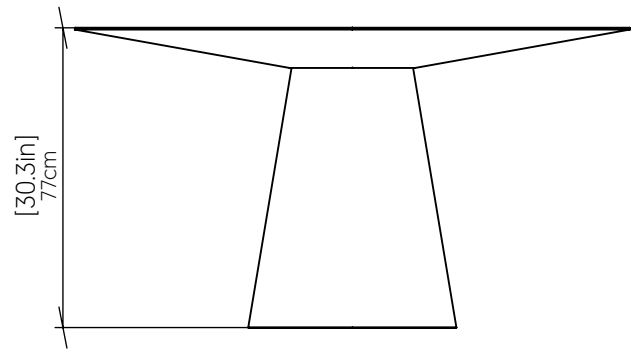

F1000

Name: Conic Side Table F1000
 Collection: Conic
 Application: Side Table
 Construction: Natural Wood Veneer, MDF

Fixture Image



Specifications

Style: Modern Contemporary
 Design Year: 2023
 Maximum Supported Weight: Kg
 Table Weight: Kg

Finishing Options

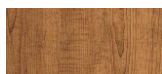

06
Imbuia



09
Louro Freijó



12
Teak

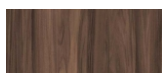

18
Walnut



34
Maple



43
Cathedral Freijó



44
Charcoal



45
Sand

Technical Drawing

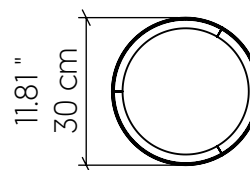
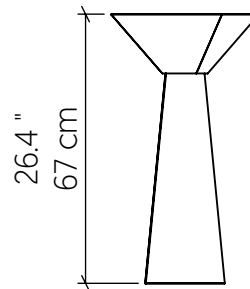

F1001

Name: Conic Side Table F1001
 Collection: Conic
 Application: Side Table
 Construction: Natural Wood Veneer, MDF

Fixture Image



Specifications

Style: Modern Contemporary
 Design Year: 2023
 Maximum Supported Weight: Kg
 Table Weight: Kg

Finishing Options

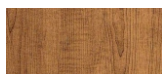

06
Imbuia



09
Louro Freijó



12
Teak

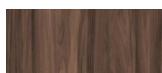

18
Walnut



34
Maple



43
Cathedral Freijó



44
Charcoal



45
Sand

Technical Drawing

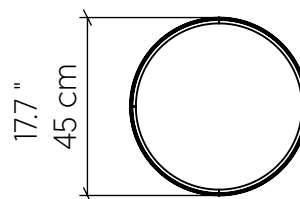
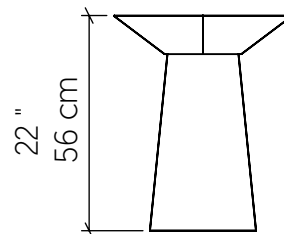

F1002

Name: Conic Side Table F1002
 Collection: Conic
 Application: Side Table
 Construction: Natural Wood Veneer, MDF

Fixture Image



Specifications

Style: Modern Contemporary
 Design Year: 2023
 Maximum Supported Weight: Kg
 Table Weight: Kg

Finishing Options

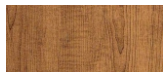

06
Imbuia



09
Louro Freijó



12
Teak



18
Walnut



34
Maple



43
Cathedral Freijó



44
Charcoal



45
Sand

Technical Drawing

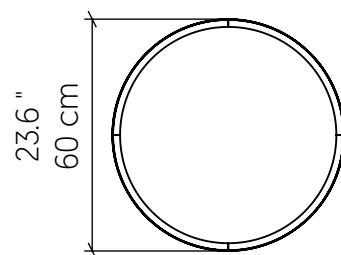
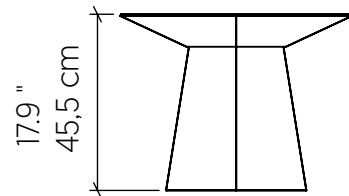

F1003

Name: Conic Side Table F1003
 Collection: Conic
 Application: Coffee Table
 Construction: Natural Wood Veneer, MDF

Fixture Image



Specifications

Style: Modern Contemporary
 Design Year: 2023
 Maximum Supported Weight: _____ Kg
 Table Weight: _____ Kg

Finishing Options

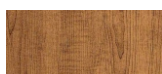

06
Imbuia



09
Louro Freijó



12
Teak

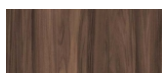

18
Walnut



34
Maple



43
Cathedral Freijó



44
Charcoal



45
Sand

Technical Drawing

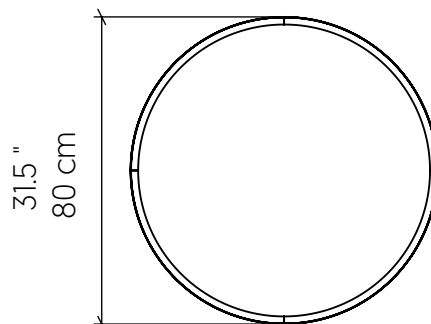
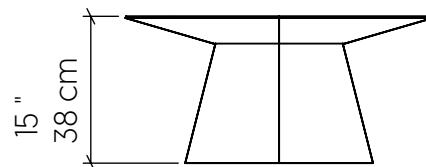

F1004

Name: Conic Side Table F1004
 Collection: Conic
 Application: Coffee Table
 Construction: Natural Wood Veneer, MDF

Fixture Image



Specifications

Style: Modern Contemporary
 Design Year: 2023
 Maximum Supported Weight: Kg
 Table Weight: Kg

Finishing Options

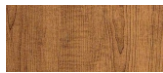

06
Imbuia



09
Louro Freijó



12
Teak



18
Walnut



34
Maple



43
Cathedral Freijó

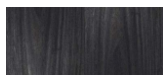

44
Charcoal



45
Sand

Technical Drawing

